

SAĽOSTATNE ŤTOJACI VEŠIAK NA KABÁTY PUJO

MONTÁŽNY MANUÁL

fermliving.com

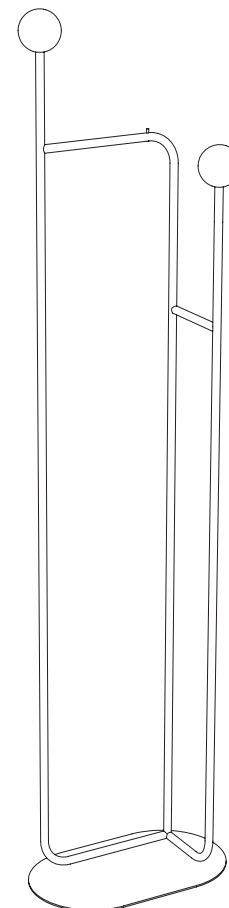

ferm
L I V I N G

OBSAH BALENIA

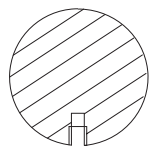

Drevená guľa

x 2



x 2



x 1

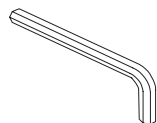

x 1



x 3

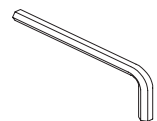

x 1

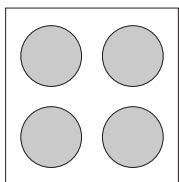

x 4

Plstené krúžky
na spodnú stranu základne

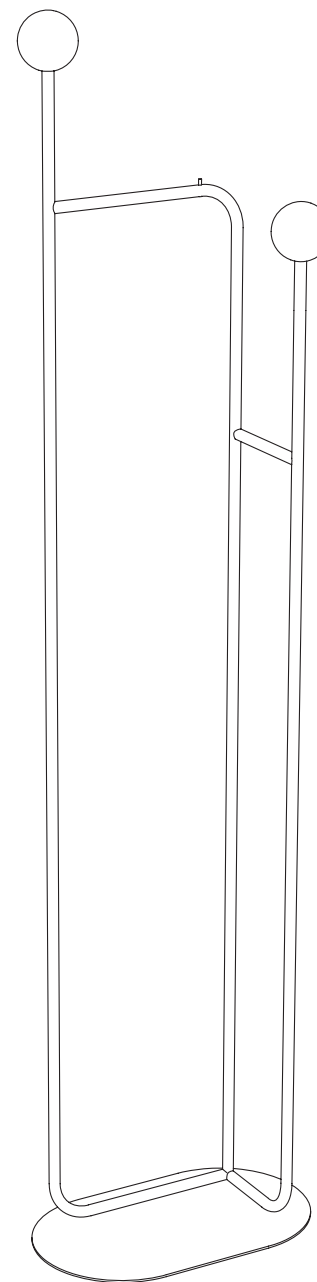

MONTÁŽNY PROCES

MONTÁŽNY PROCES

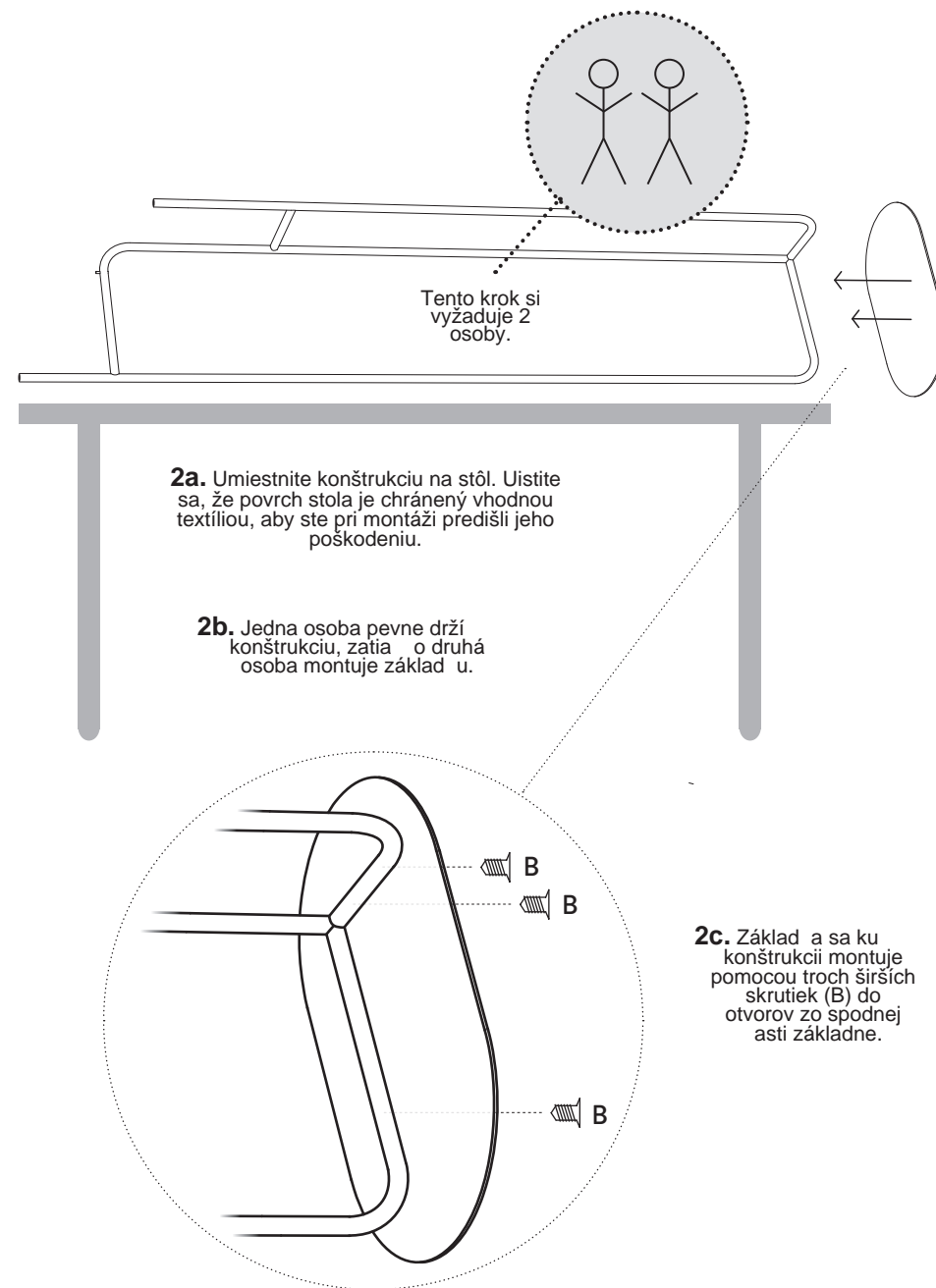
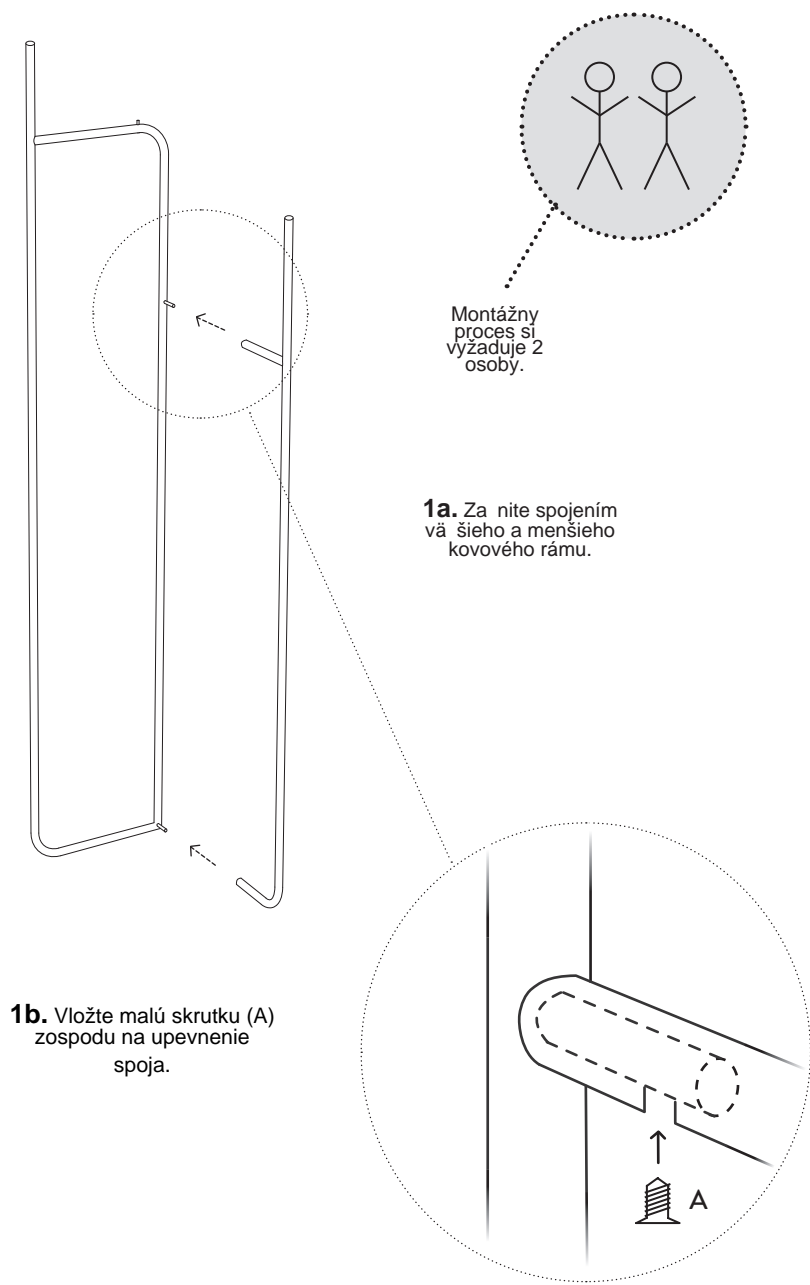

MONTÁŽNY PROCES

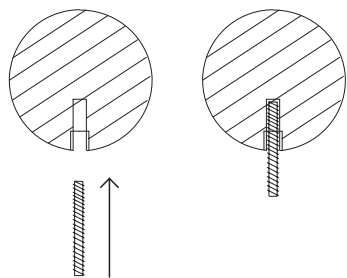

3a. Do dvoch drevených gú vložte dve dlhé skrutky.

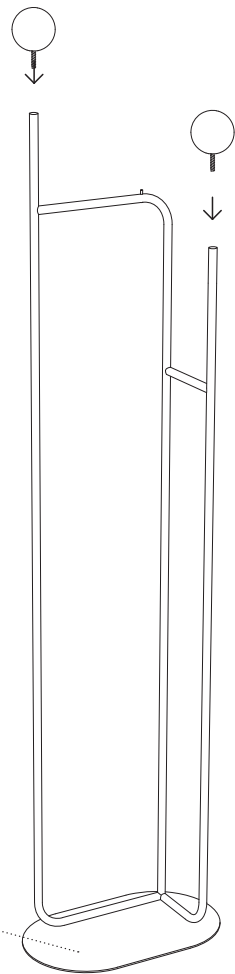

3b. Nakoniec, namontujte dve drevené gule na vrch konštrukcie.

3c. Nalepte plstené krúžky na spodnú stranu základne kvôli ochrane podlahy.

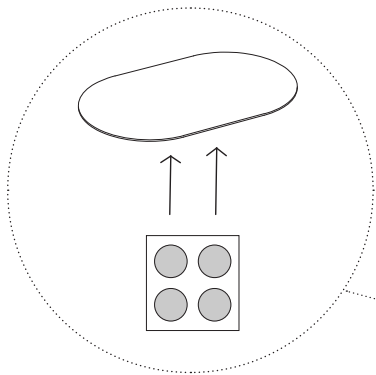

OBSAH BALENIA

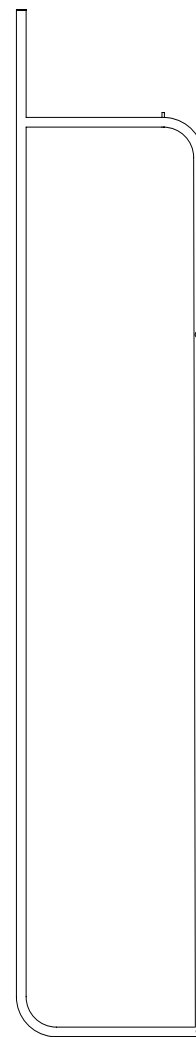

x 1



x 1



Základ a

x 1